

2. Да се спојат непрекинатите линии. Да се обојат фигурите со боја по избор

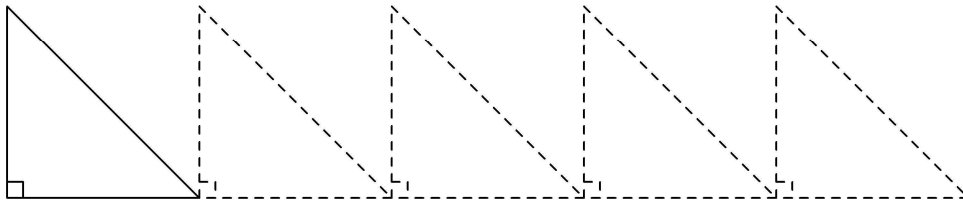

3.

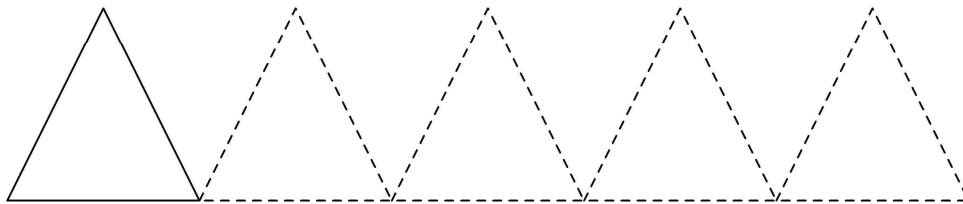

4.

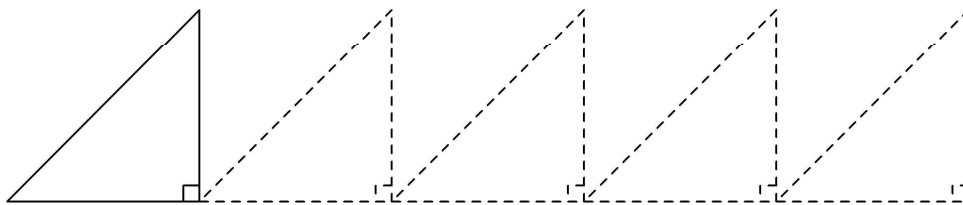

5.

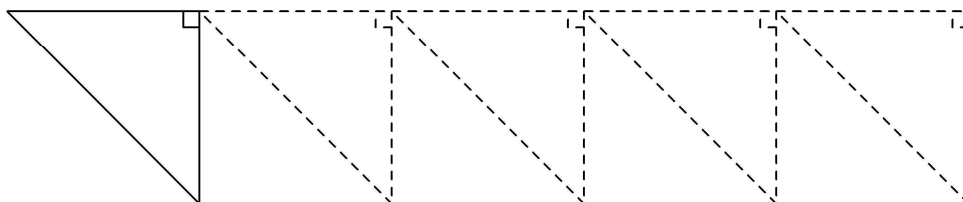

14.

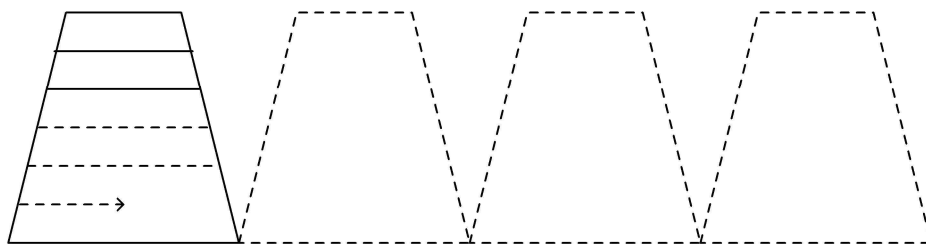

15.

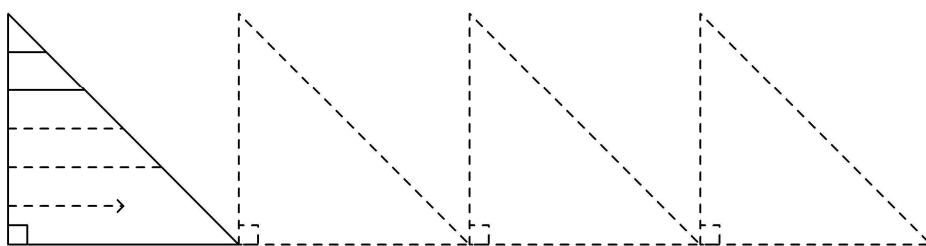

16.

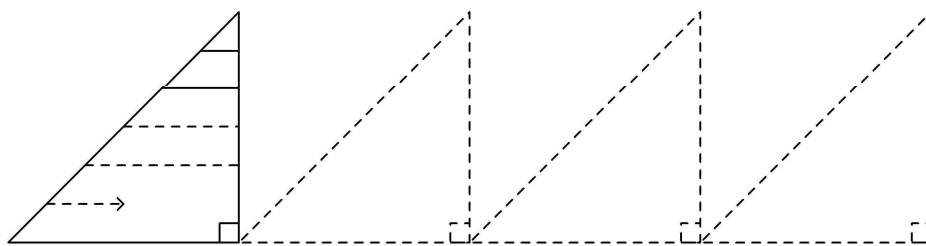

17.

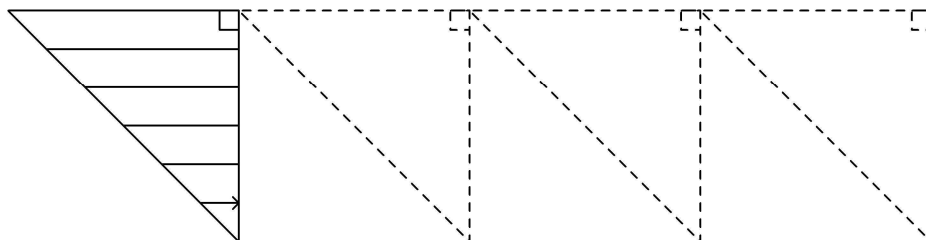

34.

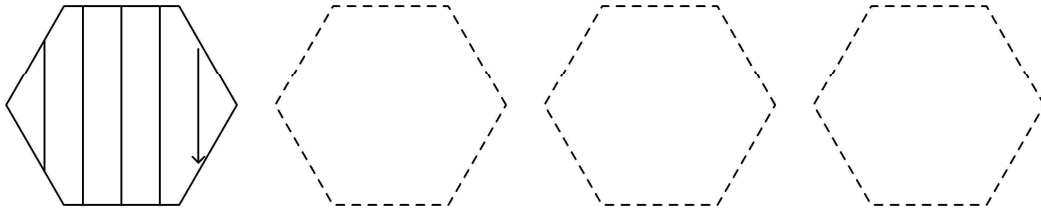

35.

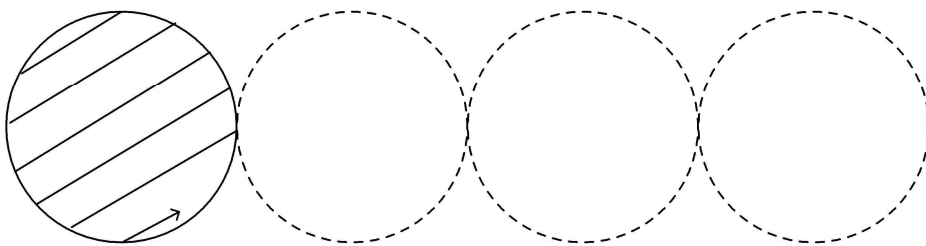

36.

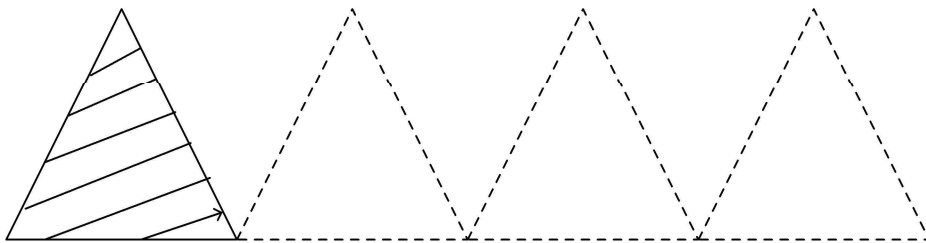

37.

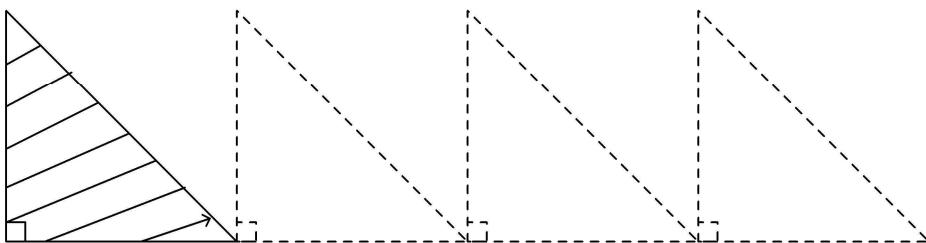

54.

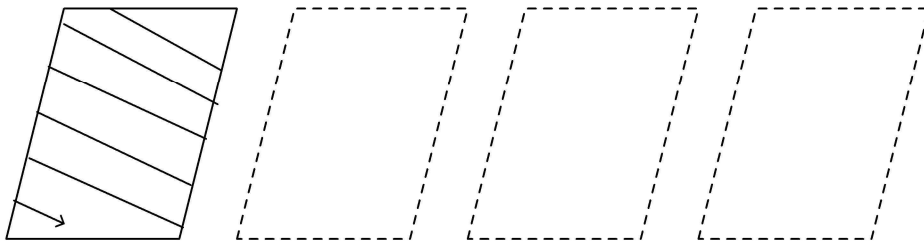

55.

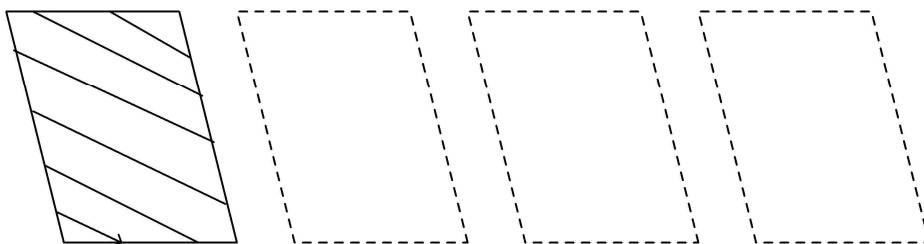

56.

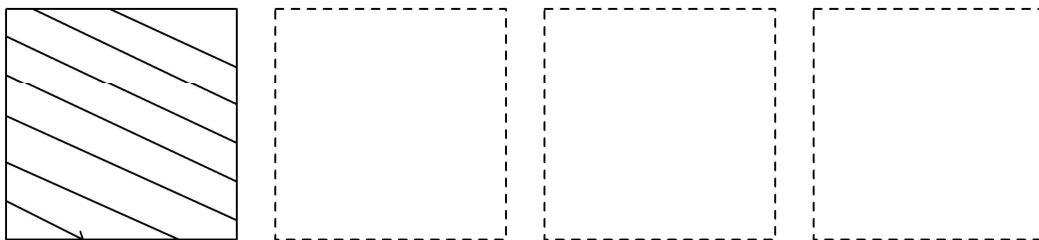

57.

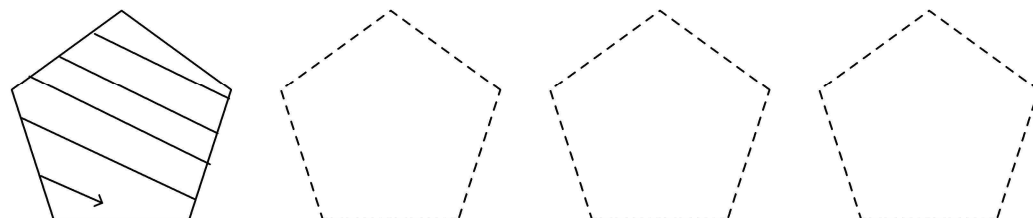

64.

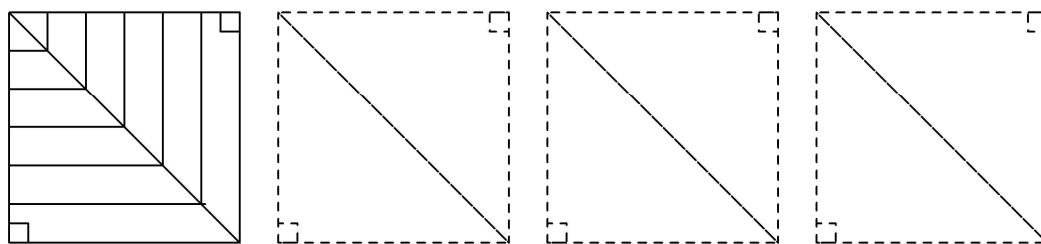

65.

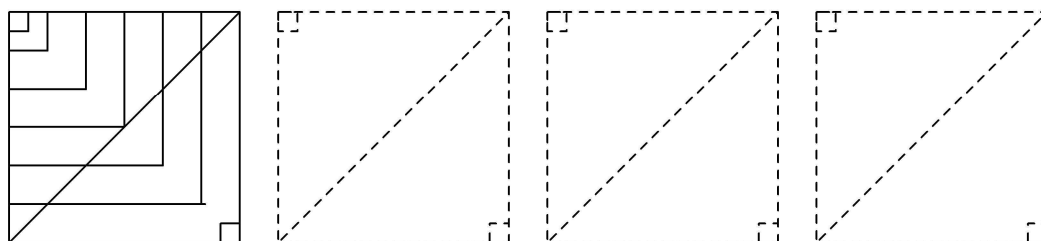

66.

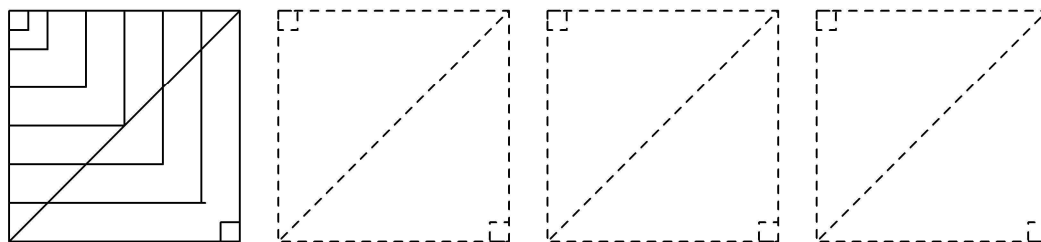

75.

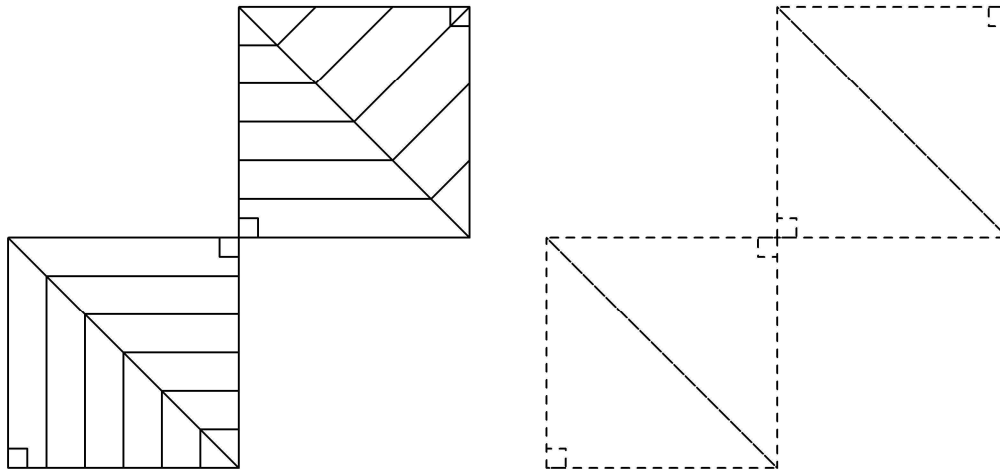

76.

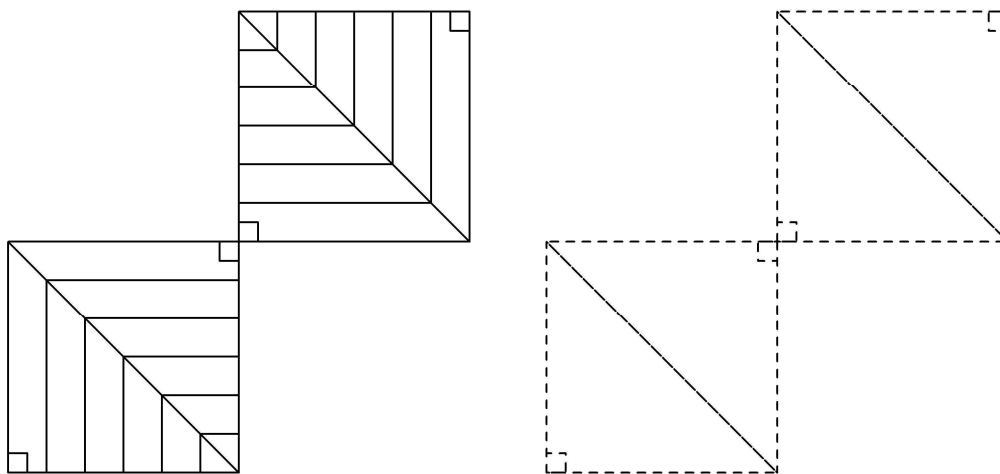

107.

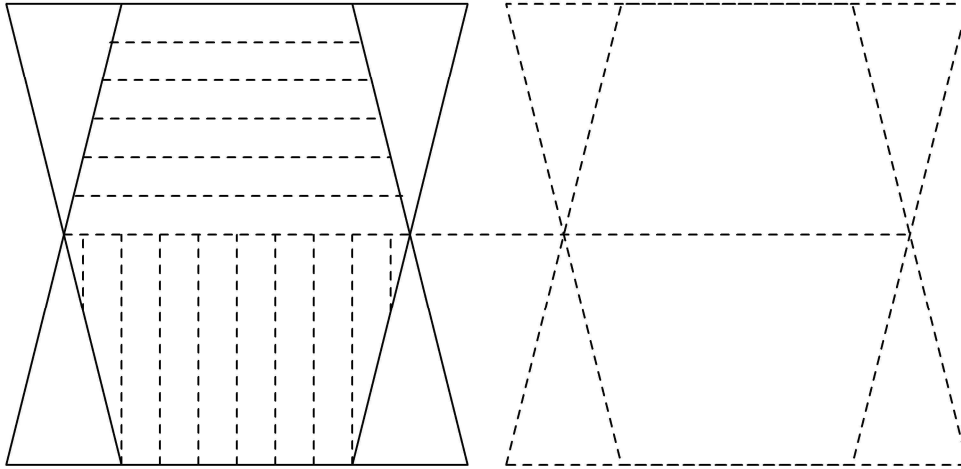

108.

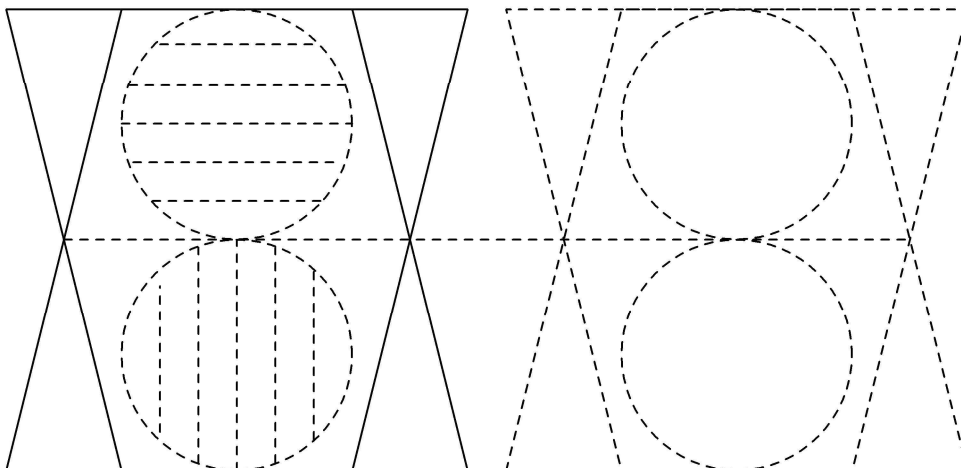

91.

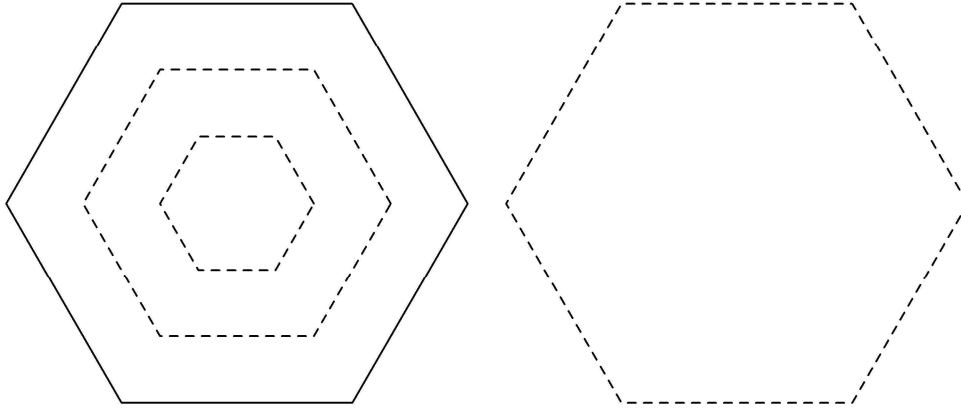

92.

